

CAPSENSE TOUCH SENSORS

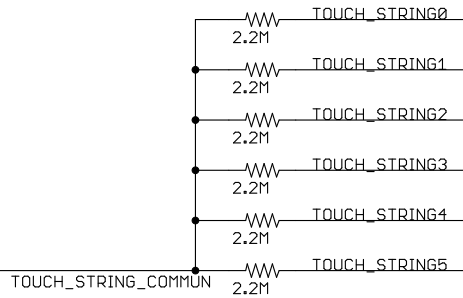

STRING LEDS

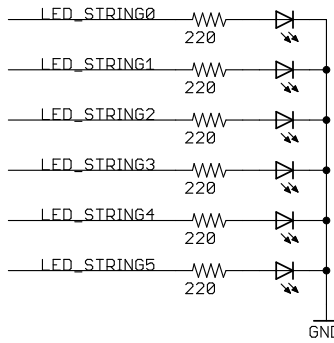

USB POWER

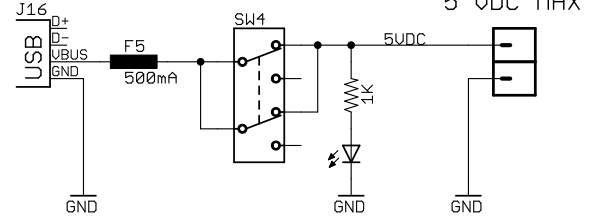

EXT. POWER 5 VDC MAX

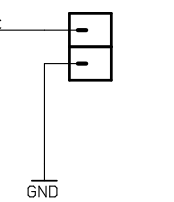

RESET BUTTON

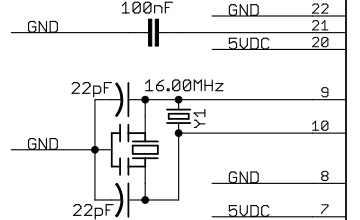
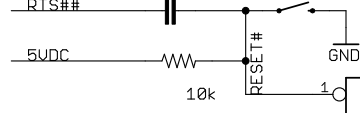

can USE RESONATOR or CRYSTAL
(CRYSTAL requires 2 x 22pF caps)

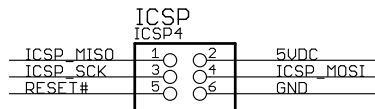
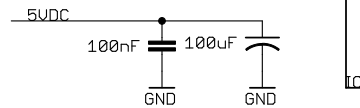

ARDUINO ATMEGA328

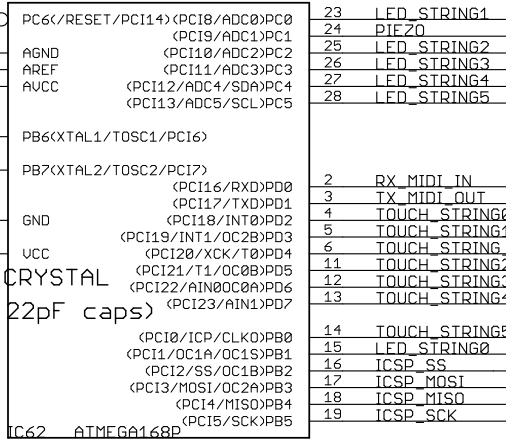

MIDI IN

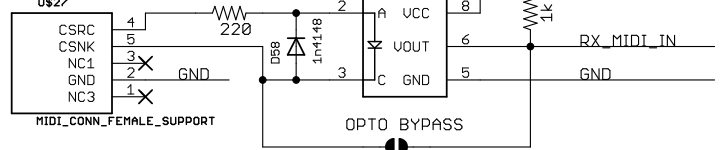

FTDI

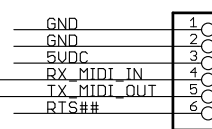

MIDI OUT

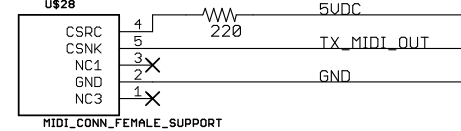

PIEZO CIRCUIT

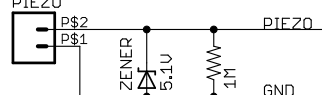

STRUMPAD ARDUINO 1.0

MIROSLAW SOWA

FEB 2, 2016